

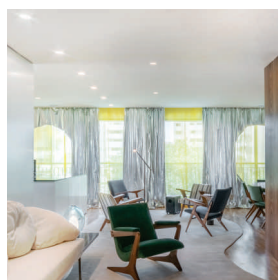

CATÁLOGO
LANÇAMENTOS 2021

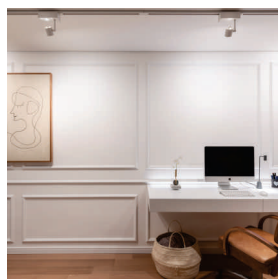

Caro cliente,

Mudanças em curso no mundo todo por conta da COVID-19 fazem deste momento ímpar um período de revisão de hábitos, costumes e valores.

Nestes **32 anos** de vida nossa atuação vem se pautando em escutar as demandas e oferecer soluções exclusivas e genuínas, comprometidos em satisfazer as necessidades de nossos **clientes** e do mercado.

Como provedores de soluções de **iluminação**, mantemos uma agenda de lançamentos periódicos de produtos além de uma preocupação crescente com qualificação de nossa equipe, melhoria de nossos processos internos e cumprimento de nosso papel **social** e **ambiental**.

Atravessamos este período com confiança, altivez e, sobretudo, **respeito** aos nossos colaboradores e clientes.

Nas próximas páginas você terá acesso ao material de nossos **lançamentos** deste ano de **2021**, que já estão disponíveis para consulta em nosso novo **site**, **completamente reformulado**.

TUBE - MINI

Spot LED com driver integrado, dissipação no corpo, e lente cambiável

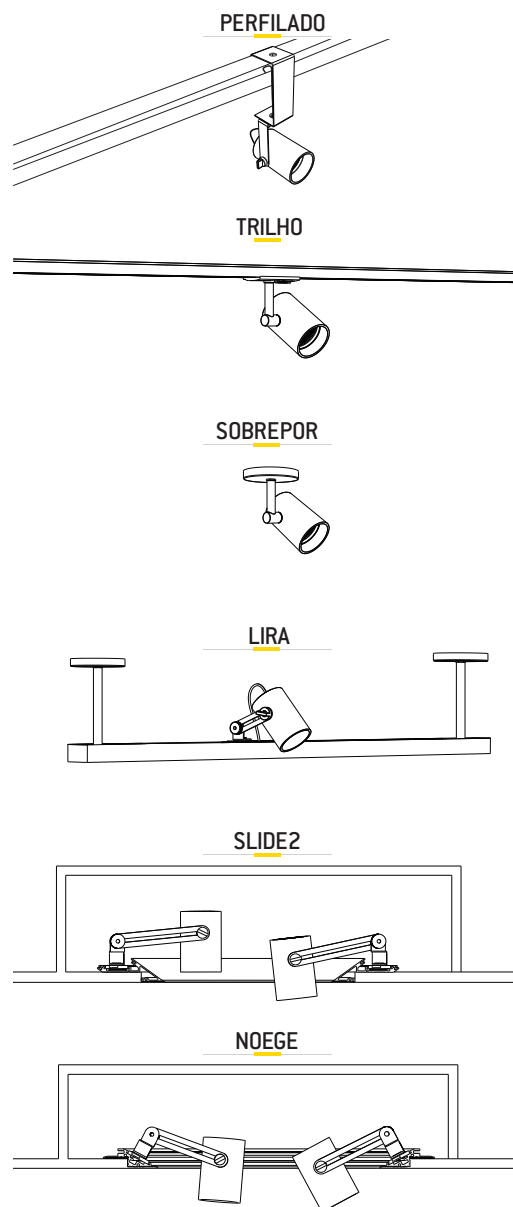

CONFIGURANDO SEU SPOT:

APLICAÇÃO:	TEMPDE COR:	CRI:	FLUXO(LM):	FACHO:	ACESSÓRIO:	CONTROLE:
PERFILADO	2700K	>90	ON/OFF: 550lm	12°	HONEYCOMB	ON/OFF
TRILHO	3000K		DIM FP: 725lm	24°	DIFUSOR	FORWARD-PHASE
SOBREPOR	4000K			38°	LENTE 12°	LUTRON 2 WIRE
LIRA				60°	LENTE 24°	
					LENTE 38°	
					LENTE 60°	

*OBS: FLUXOS PARA OS VALORES DE REFERÊNCIA DE 3000K, CRI 90

FACHOS / FOTOMETRIAS:

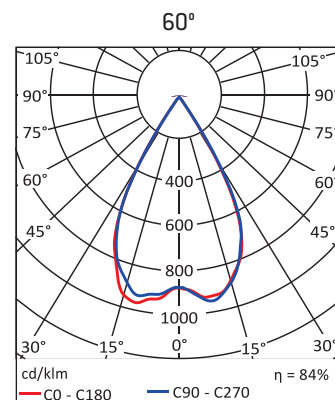
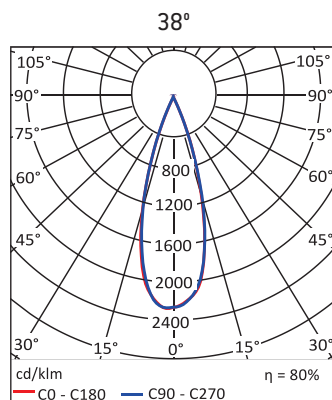
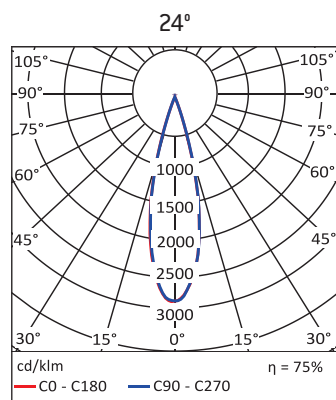
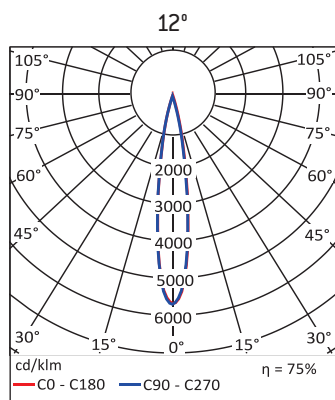

CARACTERÍSTICAS:

UTILIZAÇÃO	ILUMINAÇÃO GERAL E/OU DE DESTAQUE	
FONTE LUMINOSA	LED COB	
FACHOS (°)	12° / 24° / 38° / 60°	
TEMPERATURA DE COR	2700K / 3000K / 4000K	
DRIVER:	ON / OFF	DIM FORWARD PHASE
POTÊNCIA DO LED (W)	4,9	6,6
FLUXO LUMINOSO (LM)*	550	725
CORRENTE (mA)	150	200
CRI	80 / 90 / 95	
ALIMENTAÇÃO	110 / 220 VAC	
CONTROLE	ON-OFF / FORWARD-PHASE / LUTRON 2 WIRE	
IP	20	

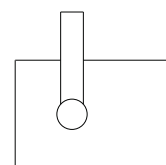

4,9 W / 550 lm
OU
6,6 W / 725 lm

*OBS: FLUXOS PARA A REFERÊNCIA DE 3000K EM CRI 90

OBS: A luminária comporta o alojamento interno para os drivers on/off e forward-phase. Lutron 2 Wire requer instalação remota.

DIMENSÕES:

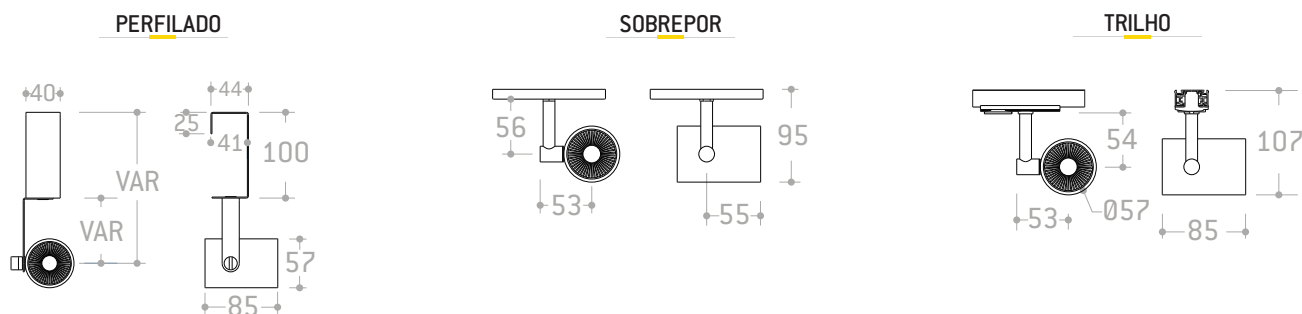

DIMENSÕES EM MILÍMETROS (mm)

INOVA 1EL

Downlight LED de embutir com fechos de 12° a 60°, com recuo para maior conforto visual

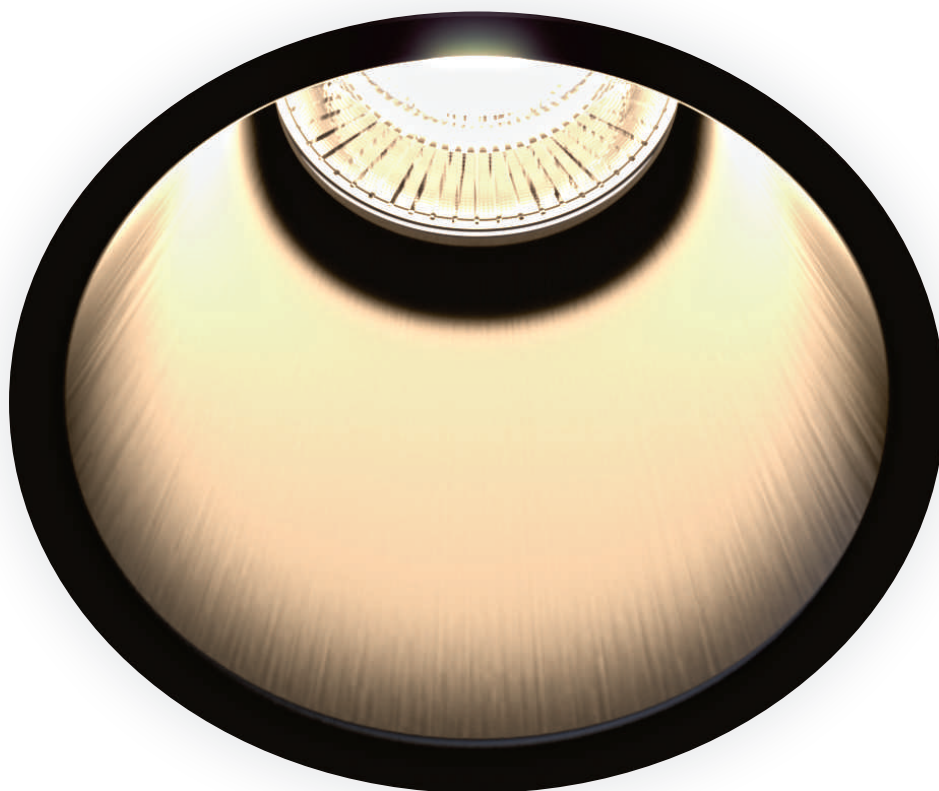

FORRO

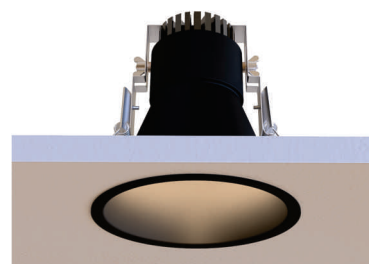

CONFIGURANDO SEU SPOT:

MODELO:	TEMP.DE COR:	CRI:	FLUXO[*]/TAM:	FACHO:	ACESSÓRIO:	CONTROLE:	
INOVA LENTE	2700K	>90	495lm	P	12°	HONEYCOMB	ON/OFF
	3000K		895lm	P	24°	DIFUSOR	FORWARD-PHASE
	4000K		1220lm	M	38°	LENTE 12°	LUTRON 2 WIRE
			1685lm	G	60°	LENTE 24°	DALI
					LENTE 38°	0-10V	
					LENTE 60°	PUSH-DIM	

*OBS: FLUXOS PARA OS VALORES DE REFERÊNCIA DE 3000K, CRI 90

FACHOS / FOTOMETRIAS:

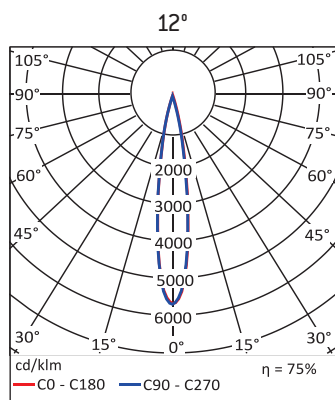

CCT 3000K, CRI90

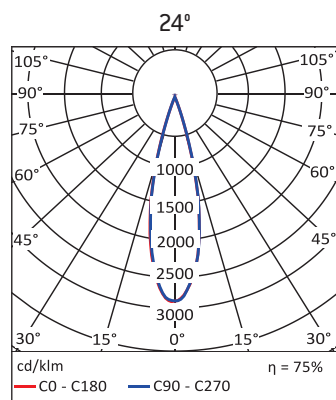

CCT 3000K, CRI90

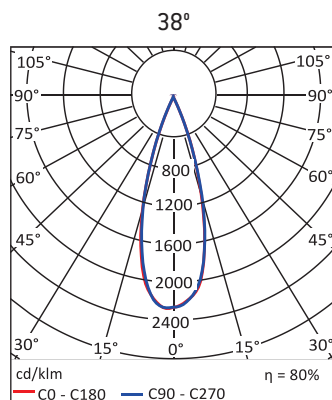

CCT 3000K, CRI90

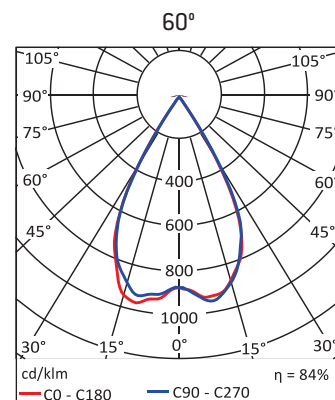

CCT 3000K, CRI90

CARACTERÍSTICAS:

MODELO	INOVA LENTE (IN1EL)		
UTILIZAÇÃO	ILUMINAÇÃO GERAL E/OU DE DESTAQUE		
FONTE LUMINOSA	LED COB		
FACHOS (°)	12° / 24° / 38° / 60°		
TEMPERATURA DE COR	2700K / 3000K / 4000K		
TAMANHO (H)	P [117,0 MM]	M [144,0 MM]	G [174,0 MM]
FLUXO LUMINOSO (LM)*	495	895	1220
POTÊNCIA (W)	4,4	8,4	12,1
CRI	80 / 90 / 95		
ALIMENTAÇÃO	110 / 220 VAC		
CONTROLE	ON-OFF / FORWARD-PHASE / LUTRON 2 WIRE / DALI / 0-10V / PUSH-DIM		
IP	20		

*OBS: FLUXOS PARA A REFERÊNCIA DE 3000K EM CRI 90

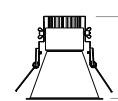

P: 4,4 W / 495 lm
OU 8,4 W / 895 lm

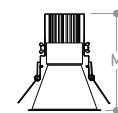

M: 12,1 W / 1220 lm

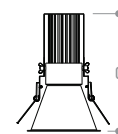

G: 18,0 W / 1685 lm

DIMENSÕES:

VISTA INFERIOR

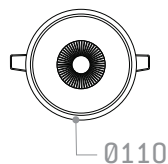

VISTA FRONTAL

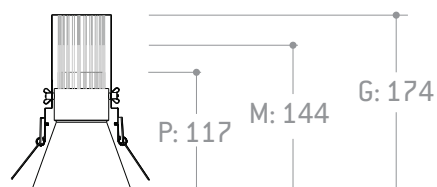

DIMENSÕES EM MILÍMETROS (mm)

INOVA 1E40

Downlight LED de embutir de luz difusa

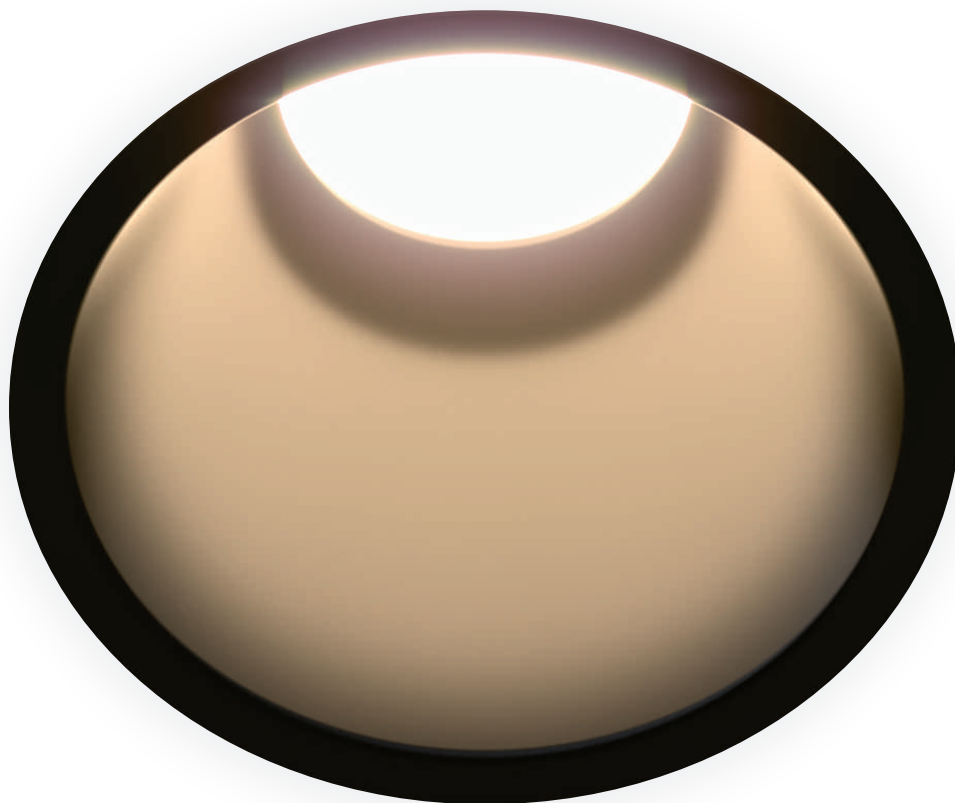

FORRO

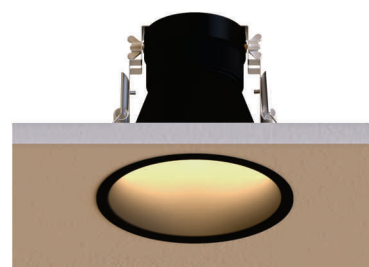

CONFIGURANDO SEU SPOT:

MODELO:	TEMP.DE COR:	CRI:	FLUXO(LM):	ACESSÓRIO:	CONTROLE:
INOVA DIFUSA	2700K 3000K 4000K	>90	495 lm	HONEYCOMB	ON/OFF FORWARD-PHASE LUTRON 2 WIRE DALI 0-10V PUSH-DIM

*OBS: FLUXO PARA A REFERÊNCIA DE 3000K EM CRI 90

CARACTERÍSTICAS:

MODELO	INOVA DIFUSA (IN1E40)
UTILIZAÇÃO	ILUMINAÇÃO GERAL
FONTE LUMINOSA	LED
TEMPERATURA DE COR	2700K / 3000K / 4000K
POTÊNCIA DO LED (W)	6,5
FLUXO LUMINOSO (LM)*	495
CRI	80 / 90 / 95
ALIMENTAÇÃO	110 / 220 VAC
CONTROLE	ON-OFF / FORWARD-PHASE / LUTRON 2 WIRE / DALI / 0-10V / PUSH-DIM
IP	20

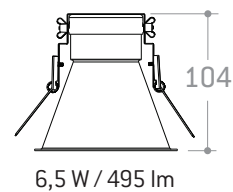

*OBS: FLUXO PARA A REFERÊNCIA DE 3000K EM CRI 90

DIMENSÕES:

VISTA INFERIOR

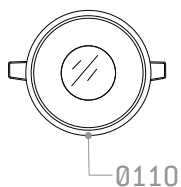

VISTA FRONTAL

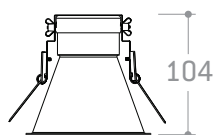

DIMENSÕES EM MILÍMETROS (mm)

LIRA PENDENTE

Sistema linear pendente para fixação de spots e/ou luz indireta



LUZ INDIRETA

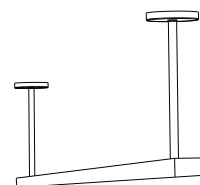

SPOTS

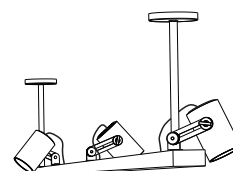

LUZ INDIRETA E/OU SPOTS

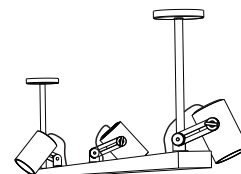

SUSPENSO POR CABO-DE-AÇO
LUZ INDIRETA E/OU SPOTS

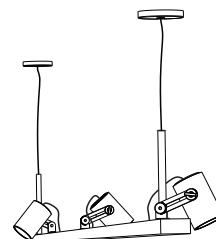

CONFIGURANDO SUA LUMINÁRIA:

TIPO DE FIXAÇÃO:	APLICAÇÃO:	TEMP.DE COR:	CRI:	FLUXO(LM/M):	CONTROLE:
- HASTE RÍGIDA	LUZ INDIRETA	2700K	>90	260 a 1625	ON/OFF
- SUSPENSO POR CABO-DE-AÇO	SPOTS	3000K			FORWARD-PHASE
	LUZ INDIRETA E SPOTS	4000K			LUTRON 2 WIRE
					DALI
					0-10V
					PUSH-DIM

*OBS: FLUXOS PARA OS VALORES DE REFERÊNCIA DE 3000K, CRI 90

CARACTERÍSTICAS:

UTILIZAÇÃO	ILUMINAÇÃO GERAL E/OU DE DESTAQUE
FONTE LUMINOSA	BARRA LED
TEMPERATURA DE COR	2700K / 3000K / 4000K
POTÊNCIA DO LED (W/M)	4,2 a 26,4
FLUXO LUMINOSO (LM/M)*	260 a 1625
CRI	80 / 90 / 95
ALIMENTAÇÃO	110 / 220 VAC
CONTROLE	ON-OFF / FORWARD-PHASE / LUTRON 2 WIRE / DALI / 0-10V / PUSH-DIM
IP	20

*OBS: FLUXOS PARA A REFERÊNCIA DE 3000K EM CRI 90

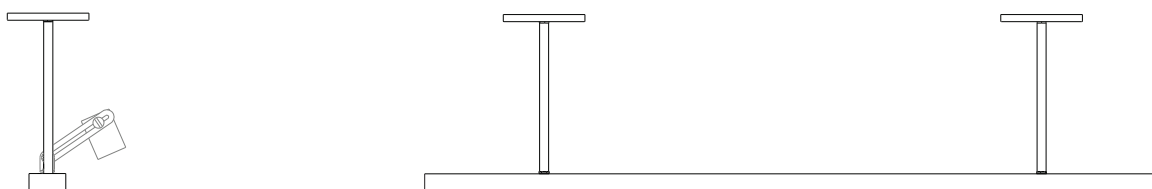

4,2 a 26,4 W/m
260 a 1625 lm/m

MODELOS DE SPOTS COMPATÍVEIS			
TUBE MINI	550 lm / 725 lm		
TUBE LED	560 lm		
TAMANHOS:	P	M	G
TUBE WINNIE	495 / 895 lm	1220 lm	1685 lm
ALETTATO MINI	1685 / 2425 lm	3035 lm
ALETTATO 2	2550 lm	3190 / 3610 lm	5090lm
ALETTATO REFLETOR	2335 lm	2920 / 3305 lm	4660lm

DIMENSÕES:

VISTA FRONTAL



VISTA LATERAL ESQUERDA

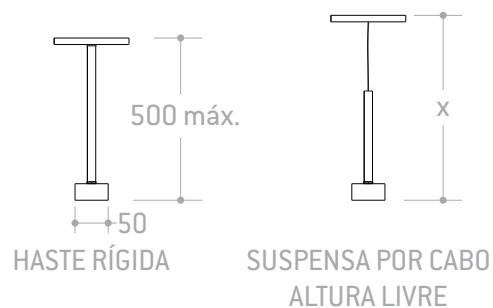

VISTA SUPERIOR



DIMENSÕES EM MILÍMETROS (mm)

LIRA ARANDELA

Arandela linear de luz uplight. Comprimento sob medida.

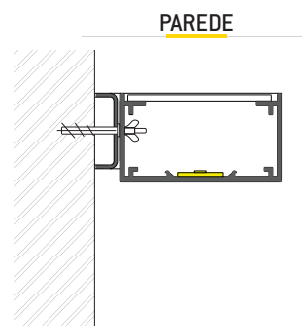
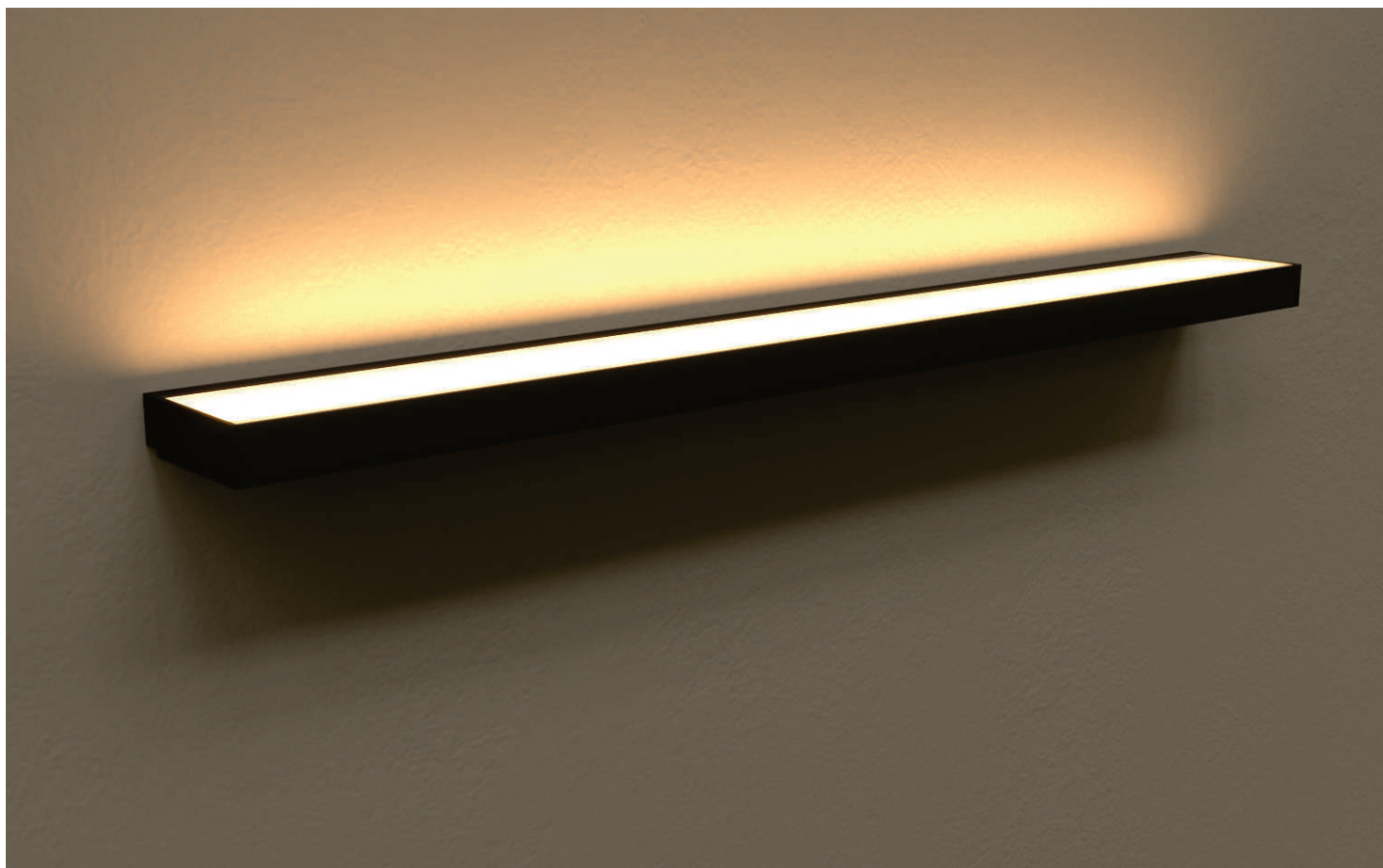

CONFIGURANDO SUA LUMINÁRIA:

MODELO:	TEMP. DE COR:	CRI:	FLUXO(LM/M):	CONTROLE:
LIRA ARANDELA	2700K 3000K 4000K	>90	260 a 1625	ON/OFF FORWARD-PHASE LUTRON 2 WIRE DALI 0-10V PUSH-DIM

*OBS: FLUXOS PARA OS VALORES DE REFERÊNCIA DE 3000K, CRI 90

CARACTERÍSTICAS:

UTILIZAÇÃO	ILUMINAÇÃO AMBIENTE
FONTE LUMINOSA	FITA ou BARRA LED
TEMPERATURA DE COR	2700K / 3000K / 4000K
POTÊNCIA DO LED (W/M)	4,2 a 26,4
FLUXO LUMINOSO (LM/M)*	260 a 1625
CRI	80 / 90 / 95
ALIMENTAÇÃO	110 / 220 VAC
CONTROLE	ON-OFF / FORWARD-PHASE / LUTRON 2 WIRE / DALI / 0-10V / PUSH-DIM
IP	40

*OBS: FLUXOS PARA A REFERÊNCIA DE 3000K EM CRI 90



4,2 a 26,4 W/m
260 a 1625 lm/m

OBS: A luminária não possui alojamento interno para driver. Necessário prever local remoto para sua instalação.

DIMENSÕES:

VISTA FRONTAL



VISTA LATERAL ESQUERDA

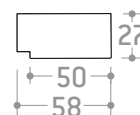

VISTA SUPERIOR



PLANUS

Pendente circular com diâmetro de 40 cm com luz indireta

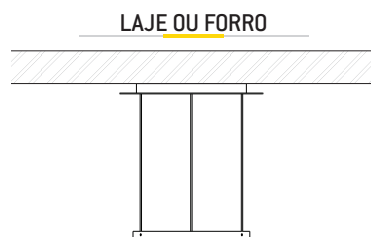

CONFIGURANDO SUA LUMINÁRIA:

MODELO:	TEMP. DE COR:	CRI:	FLUXO(LM):	CONTROLE:
PLANUS	2700K 3000K 4000K	>90	1100 2475	ON/OFF FORWARD-PHASE LUTRON 2 WIRE DALI 0-10V PUSH-DIM

*OBS: FLUXOS PARA OS VALORES DE REFERÊNCIA DE 3000K, CRI 90

CARACTERÍSTICAS:

UTILIZAÇÃO	ILUMINAÇÃO GERAL	
FONTE LUMINOSA	LED	
TEMPERATURA DE COR	2700K / 3000K / 4000K	
POTÊNCIA DO LED (W)	16,5	32,2
FLUXO LUMINOSO (LM)*	1100	2475
CRI	80 / 90 / 95	
ALIMENTAÇÃO	110 / 220 VAC	
CONTROLE	ON-OFF / FORWARD-PHASE / LUTRON 2 WIRE / DALI / 0-10V / PUSH-DIM	
IP	20	

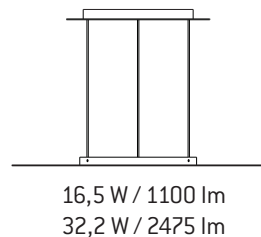

*OBS: FLUXOS PARA A REFERÊNCIA DE 3000K EM CRI 90

OBS: A luminária permite o alojamento interno da maioria dos modelos de driver disponíveis. Consulte.

DIMENSÕES:

VISTA INFERIOR

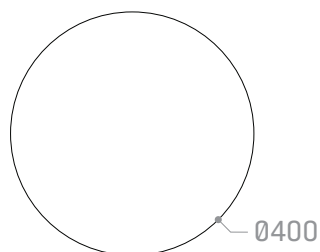

VISTA FRONTAL

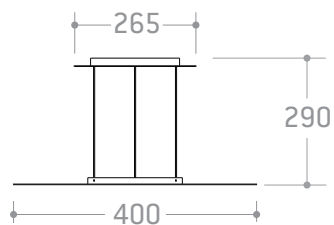

DIMENSÕES EM MILÍMETROS (mm)

SLIDE2

Perfil com acabamento para criação de rasgo com luz indireta ou fixação de spots

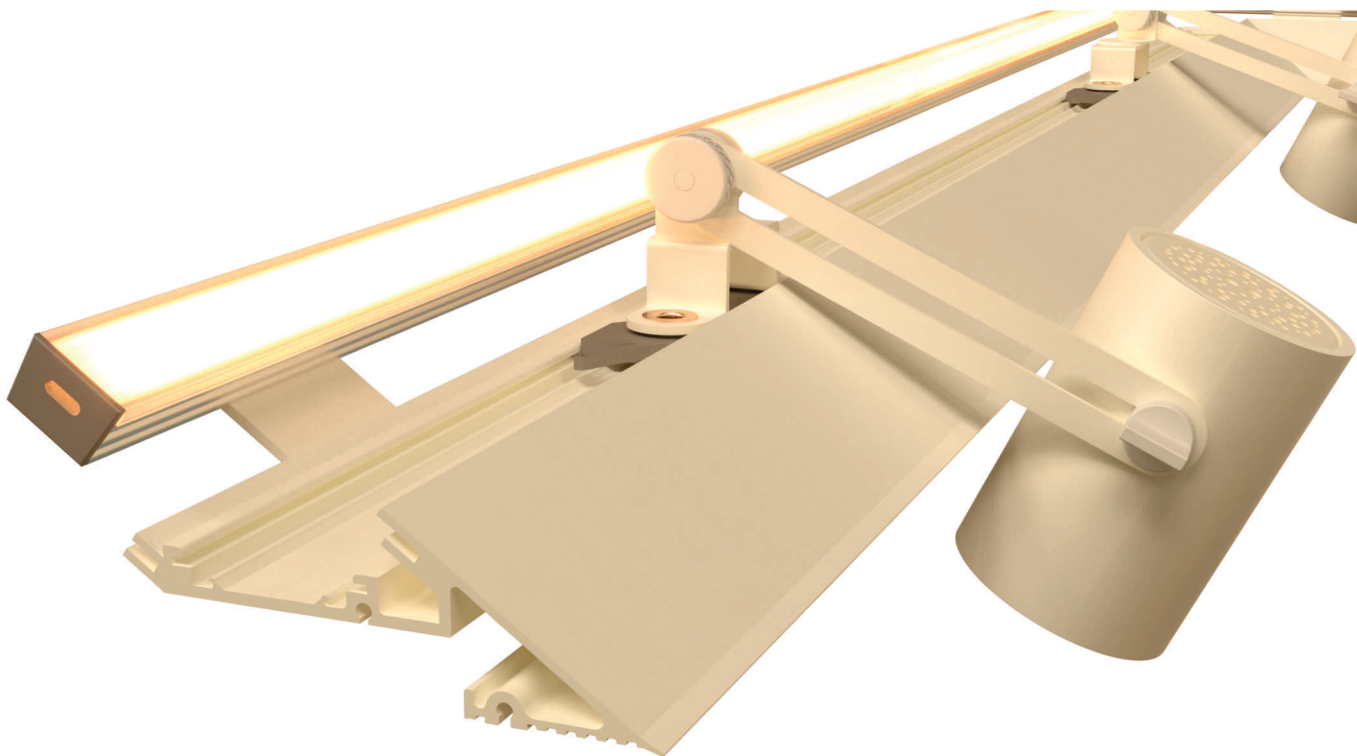

SLIDE2 perfil para a criação de rasgo iluminado ou sanca iluminada. Permite a fixação de spots com ou sem trilho eletrificado.

APLICAÇÕES DISPONÍVEIS

SANCA



SANCA INVERTIDA

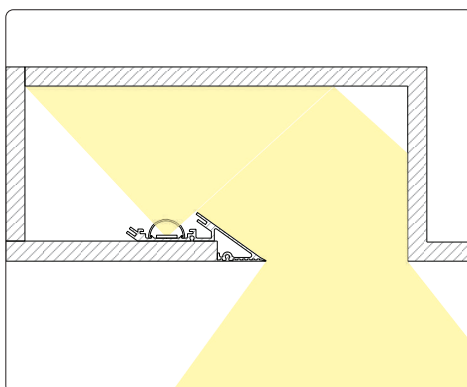

SANCA ABERTA

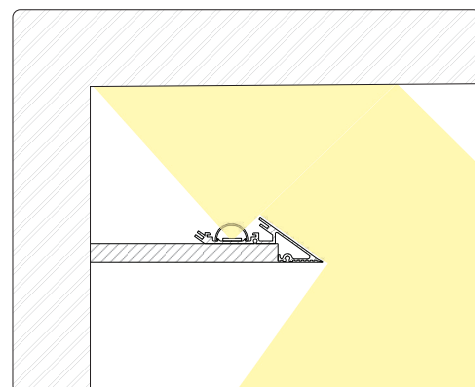

RASGO COM SPOTS E/OU LUZ INDIRETA

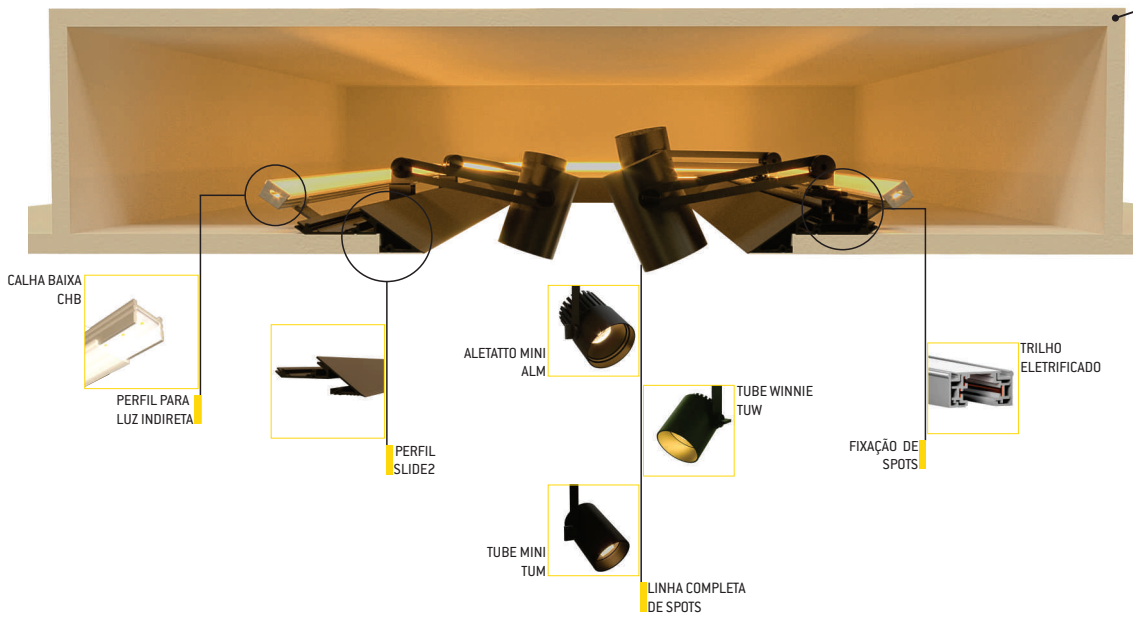

APLICADO EM FORRO COM CAIXA DE METAL OU GESSO.

- A caixa de gesso é feita pelo gesseiro na obra;
- A caixa de metal permite a integração com sistema de ar-condicionado.

RASGO COM SPOTS

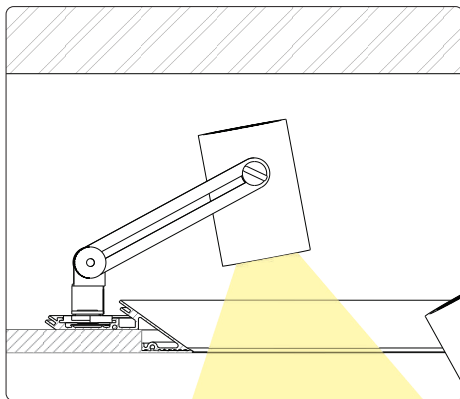

RASGO ILUMINADO COM SPOTS

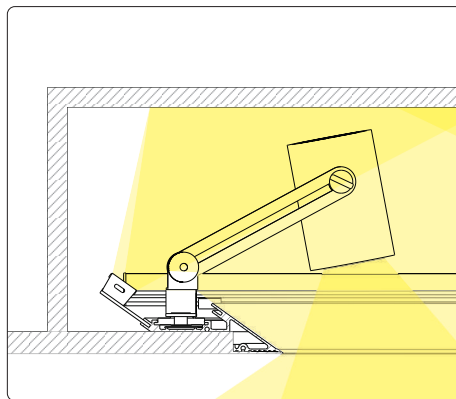

VERSÃO COM TRILHO ELETRIFICADO

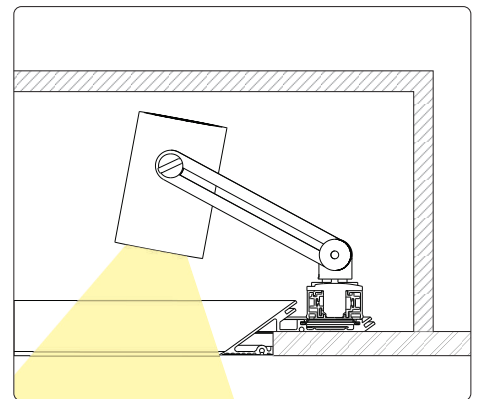

DIMENSÕES:

VISTA FRONTAL



VISTA LATERAL ESQUERDA

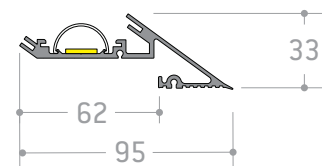

DIMENSÕES EM MILÍMETROS (mm)

RISK42

Balizador LED para caixa 4x2 com halo de luz quadrado

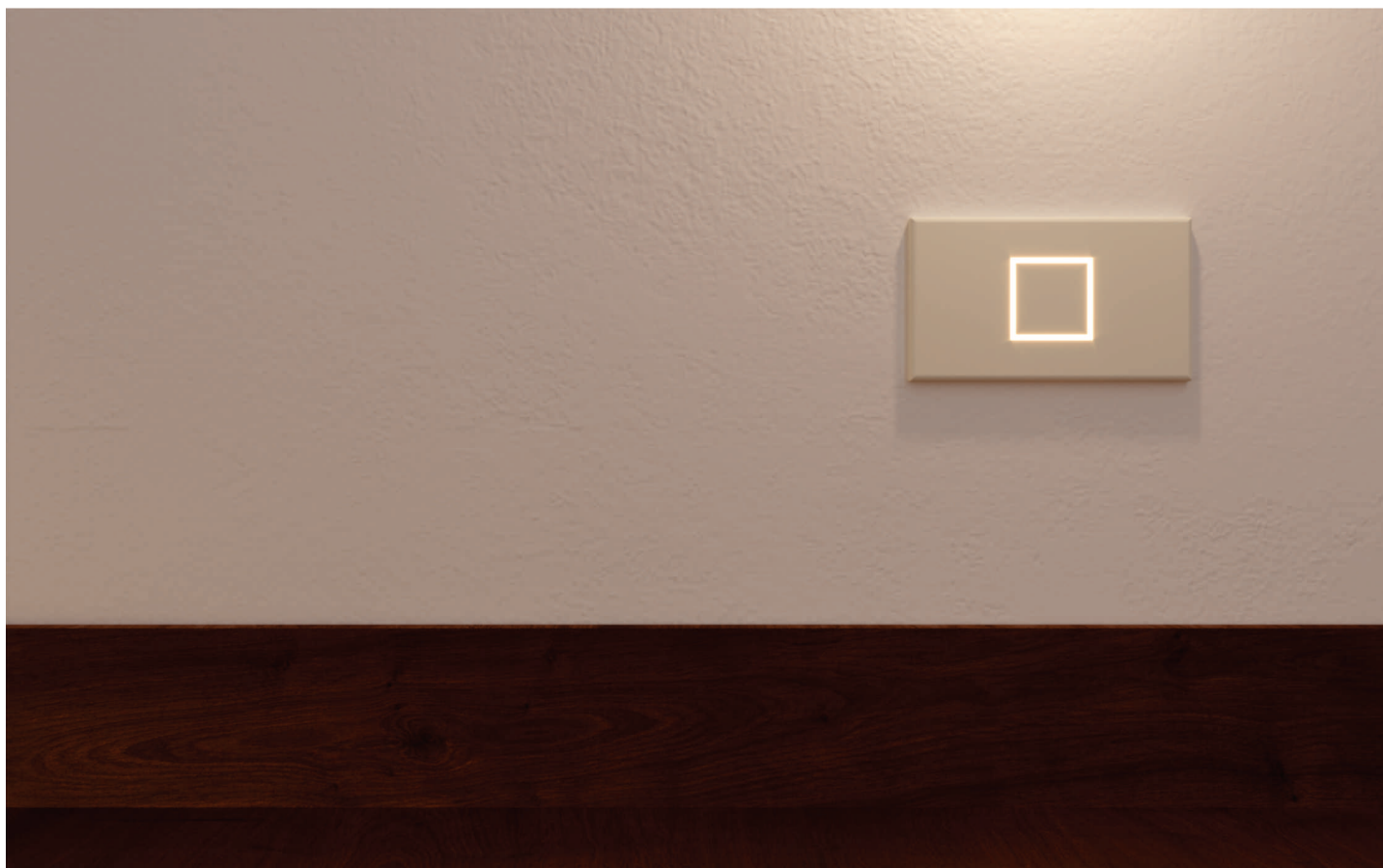

PAREDE / VERTICAL

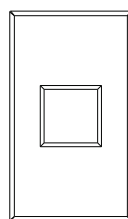

PAREDE / HORIZONTAL

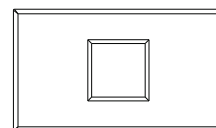

CONFIGURANDO SUA LUMINÁRIA:

MODELO:	TEMP. DE COR:	CRI:	FLUXO(LM):	CONTROLE ¹ :
RISK42	2700K 3000K 4000K	>90	60	ON/OFF FORWARD-PHASE LUTRON 2 WIRE DALI 0-10V PUSH-DIM

*OBS: FLUXO PARA A REFERÊNCIA DE 3000K EM CRI 90

CARACTERÍSTICAS:

UTILIZAÇÃO	ILUMINAÇÃO DE ORIENTAÇÃO
FONTE LUMINOSA	LED
TEMPERATURA DE COR	2700K / 3000K / 4000K
POTÊNCIA DO LED (W)	2,0
FLUXO LUMINOSO (LM)*	60
CRI	80 / 90 / 95
ALIMENTAÇÃO	110 / 220 VAC
CONTROLE	ON-OFF / FORWARD-PHASE / LUTRON 2 WIRE / DALI / 0-10V / PUSH-DIM
IP	40

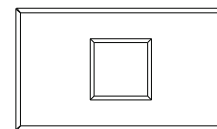

2,0W / 60lm

*OBS: FLUXO PARA A REFERÊNCIA DE 3000K EM CRI 90

NOTAS:

1- Alojamento interno para driver on/off. Demais modelos de driver instalação remota.

DIMENSÕES:

VISTA FRONTAL

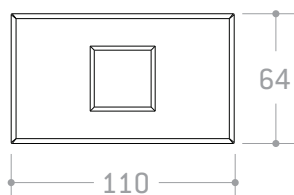

VISTA LATERAL ESQUERDA

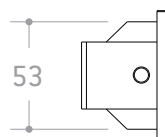

VISTA SUPERIOR

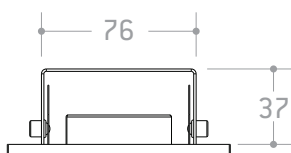

RISK55

Balizador LED de embutir com halo de luz quadrado



PAREDE

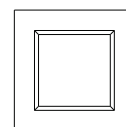

CONFIGURANDO SUA LUMINÁRIA:

MODELO:	TEMP. DE COR:	CRI:	FLUXO(LM):	CONTROLE ¹ :
RISK55	2700K 3000K 4000K	>90	60	ON/OFF FORWARD-PHASE LUTRON 2 WIRE DALI 0-10V PUSH-DIM

*OBS: FLUXO PARA A REFERÊNCIA DE 3000K EM CRI 90

CARACTERÍSTICAS:

UTILIZAÇÃO	ILUMINAÇÃO DE ORIENTAÇÃO
FONTE LUMINOSA	LED
TEMPERATURA DE COR	2700K / 3000K / 4000K
POTÊNCIA DO LED (W)	2,0
FLUXO LUMINOSO (LM)*	60
CRI	80 / 90 / 95
ALIMENTAÇÃO	110 / 220 VAC
CONTROLE	ON-OFF / FORWARD-PHASE / LUTRON 2 WIRE / DALI / 0-10V / PUSH-DIM
IP	40

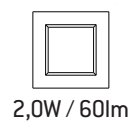

2,0W / 60lm

*OBS: FLUXO PARA A REFERÊNCIA DE 3000K EM CRI 90

NOTAS:

1- Alojamento interno para driver on/off. Demais modelos de driver instalação remota.

DIMENSÕES:

VISTA FRONTAL

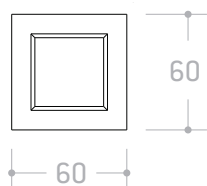

VISTA LATERAL ESQUERDA

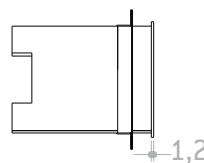

VISTA SUPERIOR

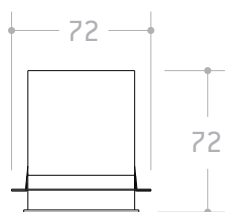

RING44

Balizador LED redondo com halo de luz circular



PAREDE

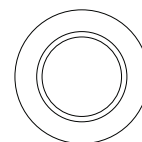

CONFIGURANDO SUA LUMINÁRIA:

MODELO:	TEMP. DE COR:	CRI:	FLUXO(LM):	CONTROLE:
RING44	2700K 3000K 4000K	>90	60	ON/OFF FORWARD-PHASE LUTRON 2 WIRE DALI 0-10V PUSH-DIM

*OBS: FLUXO PARA A REFERÊNCIA DE 3000K EM CRI 90

CARACTERÍSTICAS:

UTILIZAÇÃO	ILUMINAÇÃO DE ORIENTAÇÃO
FONTE LUMINOSA	LED
TEMPERATURA DE COR	2700K / 3000K / 4000K
POTÊNCIA DO LED (W)	2,0
FLUXO LUMINOSO (LM)*	60
CRI	80 / 90 / 95
ALIMENTAÇÃO	110 / 220 VAC
CONTROLE	ON-OFF / FORWARD-PHASE / LUTRON 2 WIRE / DALI / 0-10V / PUSH-DIM
IP	40



*OBS: FLUXO PARA A REFERÊNCIA DE 3000K EM CRI 90

NOTAS:

1- A versão com alojamento longo comporta driver on/off internamente. Para modelo curto driver de instalação remota.

DIMENSÕES:

BALIZADOR PARA DRIVER DE INSTALAÇÃO REMOTA

VISTA FRONTAL

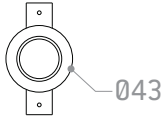

VISTA SUPERIOR



VISTA LATERAL ESQUERDA

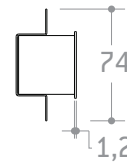

BALIZADOR COM ALOJAMENTO INTERNO PARA DRIVER¹

VISTA FRONTAL

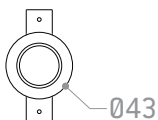

VISTA SUPERIOR

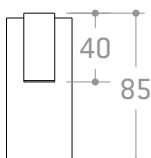

VISTA LATERAL ESQUERDA

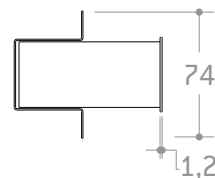

DIMENSÕES EM MILÍMETROS (mm)

Conheça nossas linhas de lineares: Embutidos / Sobrepor / Pendentes

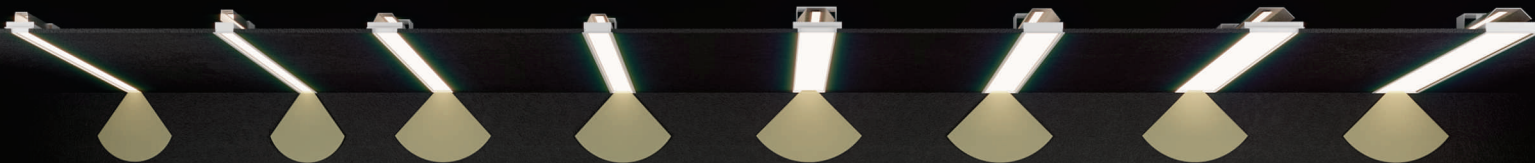

MICROLINE
DE
EMBUTIR
NO FRAME
58 (L) x 65 (H)

MICROLINE
DE
EMBUTIR
MICROBORDA
58 (L) x 65 (H)

MINILINE
DE
EMBUTIR
NO FRAME
82 (L) x 65 (H)

MINILINE
DE
EMBUTIR
MICROBORDA
82 (L) x 65 (H)

BOXLINE
DE
EMBUTIR
NO FRAME
126 (L) x 75 (H)

BOXLINE
DE
EMBUTIR
MICROBORDA
126 (L) x 75 (H)

GIGALINE
DE
EMBUTIR
NO FRAME
159 (L) x 80 (H)

GIGALINE
DE
EMBUTIR
MICROBORDA
159 (L) x 80 (H)



MINILINE
DE
SOBREPOR
82 (L) x 82 (H)



BOXLINE
DE
SOBREPOR
125 (L) x 96 (H)



GIGALINE
DE
SOBREPOR
158 (L) x 96(H)



MINILINE
PENDENTE
DOWN
82 (L) x 82 (H)



MINILINE
PENDENTE
UP+DOWN
82 (L) x 96 (H)



BOXLINE
PENDENTE
DOWN
125 (L) x 96 (H)



BOXLINE
PENDENTE
UP+DOWN
125 (L) x 96 (H)



GIGALINE
PENDENTE
DOWN
158 (L) x 96 (H)



GIGALINE
PENDENTE
UP+DOWN
158 (L) x 96 (H)

VISITE **NOSSO SITE** E CONHEÇA MAIS SOBRE NOSSA LINHA

Conheça as tabelas de fluxos das nossas linhas:
<http://www.ciadeluminacao.com.br/fluxos/>





Showroom
Rua Espártaco, 342 – Vila Romana – São Paulo, SP
contato@ciadeiluminacao.com.br
Tel.: +55 11 3371-2333
www.ciadeiluminacao.com.br

